







Abertura para dentro Lado esquerdo

Identifique os parafusos

| | | |
|----------|---|---|
| A |  | Parafuso Philips chata ST FH M 4 x 20 mm |
| B |  | Parafuso Philips chata ST FH M 4 x 25 mm |
| C |  | Parafuso Philips chata ST FH M 3,5 x 38 mm |
| D |  | Parafuso Philips chata FH M 4 x 6 mm |
| E |  | Parafuso Philips panela BH M 5 x 20 mm |
| F |  | Parafuso Philips panela BH M 5 x 35 mm |
| G |  | Parafuso Philips panela BH M 5 x 45 mm |
| H |  | Parafuso Philips panela BH M 5 x 55 mm |
| I |  | Parafuso Philips chata M 5 x 30 mm |

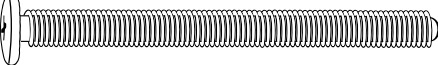
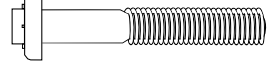
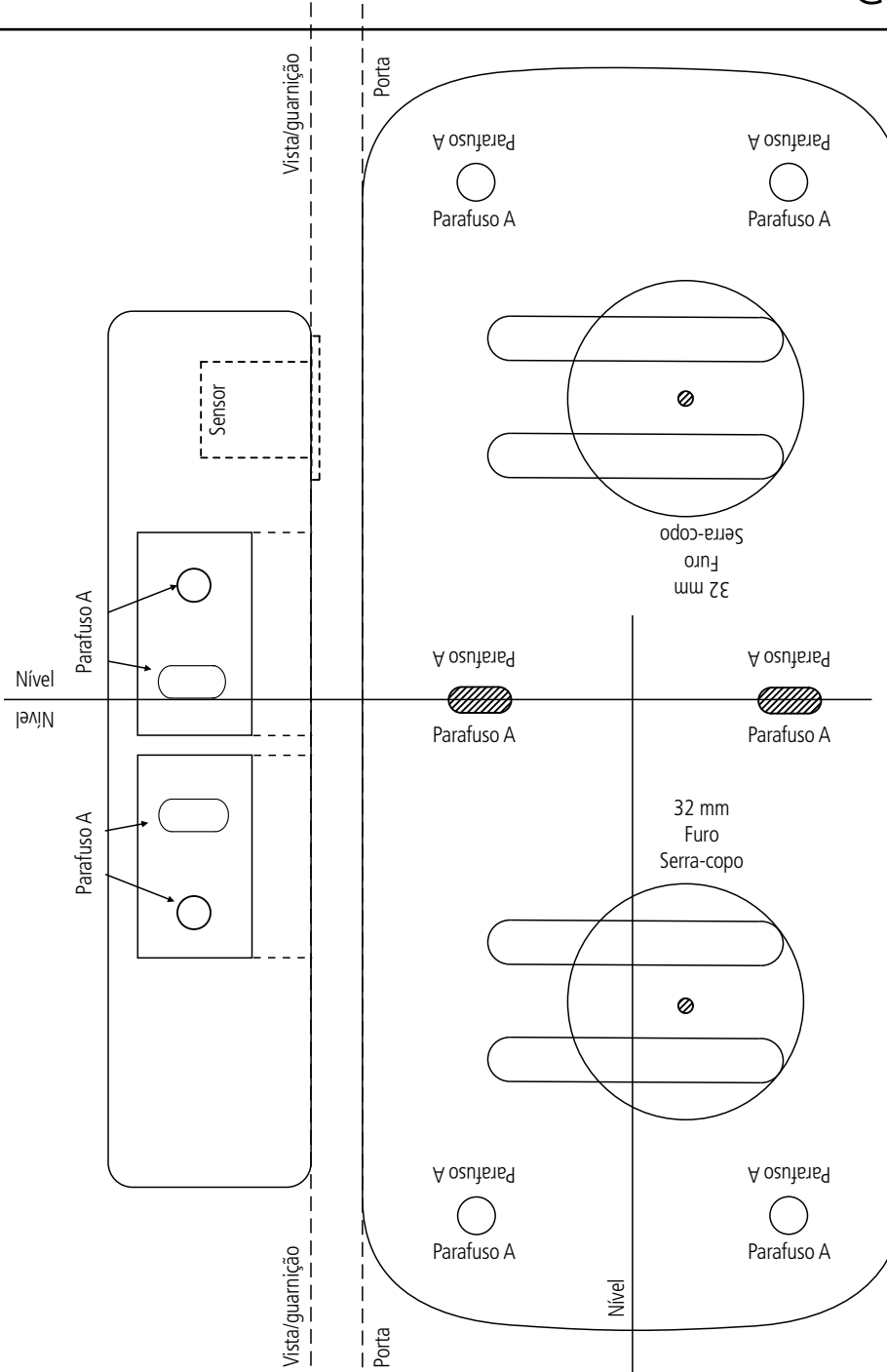

Abertura para dentro Lado direito

Abertura para fora Lado esquerdo

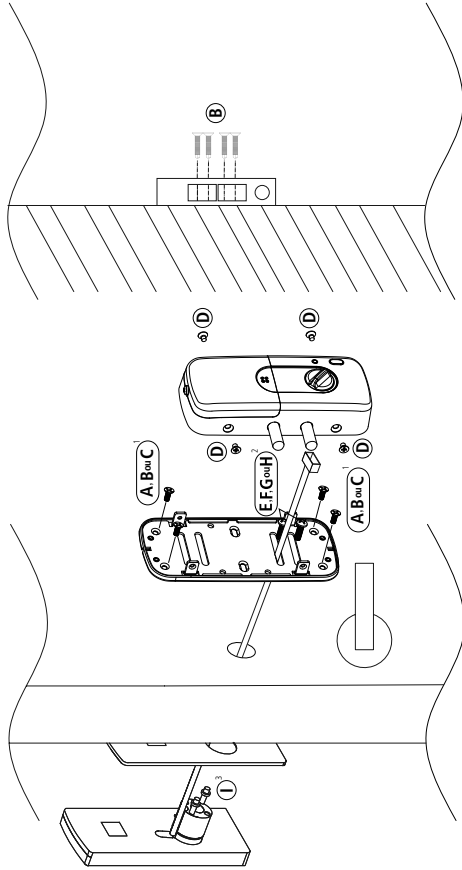

- ¹ Utilizar parafusos A para porta com espessura de 25 a 30 mm.
Utilizar parafusos B para porta com espessura de 31 a 40 mm.
Utilizar parafusos C para porta com espessura de 41 a 50 mm, ou ao utilizar calços (certifique que a espessura total - porta + calços é superior a 38 mm).
- ² Utilizar parafusos E para espessura total (porta + calços) de 25 a 35 mm.
Utilizar parafusos F para espessura total (porta + calços) de 36 a 50 mm.
Utilizar parafusos G para espessura total (porta + calços) de 51 a 60 mm.
Utilizar parafusos H para espessura total (porta + calços) de 61 a 65 mm.
- ³ Parafuso I já fixado no módulo externo. Remova-o ao instalar em portas com espessura inferior a 35 mm ou ao utilizar calços.

Abertura para fora Lado direito

